

AIRTREND Ltd.  
Predstavništvo u Beogradu  
Kumanovska 14  
11000 Beograd  
Tel: 011 3836886, 3085740  
Faks: 011 3444113  
e-mail: [gobrid@eunet.rs](mailto:gobrid@eunet.rs)  
web: [www.airtrend.rs](http://www.airtrend.rs)

# Nozzle diffuser DYVZ / Supply air unit DYVB

TECHNICAL DATA





DYVZ



DYVB (DYVZ + ATVA)

The DYVB is a quiet wall mounted supply air unit that consists of a nozzle diffuser DYVZ and a plenum box ATVA. The diffuser has adjustable nozzles for the setting of an optional diffusion pattern. The DYVB has very good mixing properties and can cope with large under-temperatures.

### QUICK SELECTION

Nozzle diffuser DYVZ with connection box ATVA (50 Pa).

Connection from the rear

Size DYVB-	Connection ATVA inlet, mm	Air flow l/s (m <sup>3</sup> /h) at sound level		
		25 dB(A)	30 dB(A)	35 dB(A)
100-1	100	16	26 (94)	39
125-1	125	20	31 (112)	52
160-1	160	34	47 (169)	71
200-1	200	40	60 (216)	85

Connection from the side

Size DYVB-	Connection ATVA inlet, mm	Air flow l/s (m <sup>3</sup> /h) at sound level		
		25 dB(A)	30 dB(A)	35 dB(A)
100-2	100	12	16 (58)	40
125-2	125	16	22 (79)	53
160-2	160	21	32 (115)	66
200-2	200	31	62 (232)	80

### PRODUCT DATA

- Easy to install and adjust
- Low sound level
- Adjustable diffusion pattern
- Choice of diffusion directions
- Four sizes: 100, 125, 160 and 200 mm
- Plenum box ATVA with patented measurement and adjustment damper (ZAEF)
- The damper is easily removable without changing the settings

### PRODUCT CODE EXAMPLE

Bundle code:

Supply air unit **DYVB-200-1**

Ordering codes:

Nozzle diffuser **DYVZ-200**

Plenum box **ATVA-200-1**

## AIR FLOW, THROW, PRESSURE DROP, SOUND LEVEL

### THROW - NORMAL DIFFUSION PATTERN

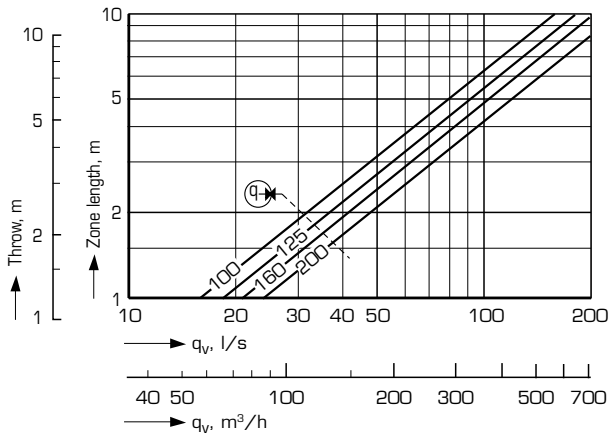

The graphs apply for nozzle air diffuser DYVB installed with its upper edge 200 mm from the ceiling. Closer positioning to the ceiling increases the throw.

### THROW - CONCENTRATED DIFFUSION PATTERN

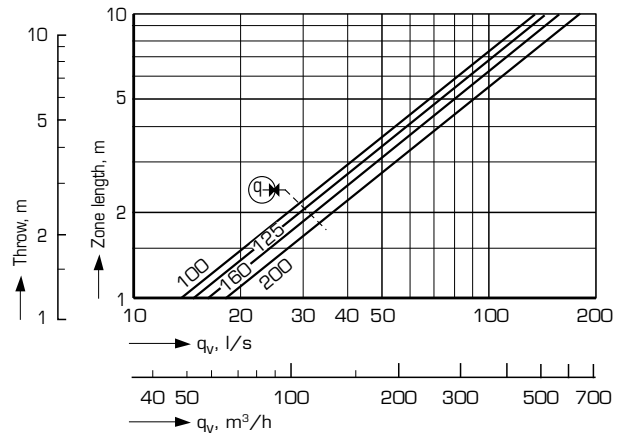

The throw and zone length are shown for two cases: normal diffusion pattern (delivery execution) and 1-way concentrated diffusion pattern.

### DYVB-100-1 WITH CONNECTION FROM THE REAR

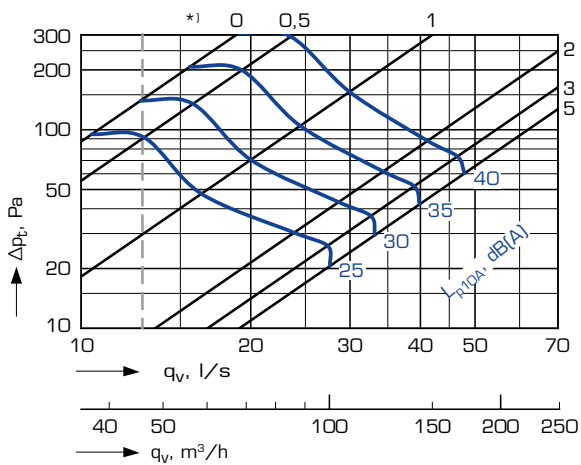

--- Min. airflow required to obtain sufficient measuring pressure.

### DYVB-100-2 WITH CONNECTION FROM THE SIDE

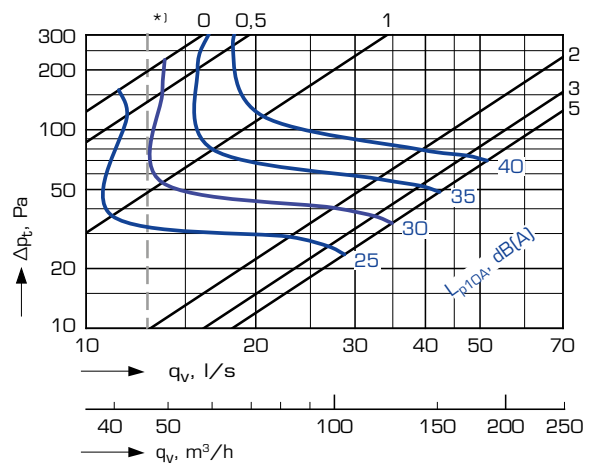

**AIR FLOW, PRESSURE DROP, SOUND LEVEL**

**DYVB-125-1 WITH CONNECTION FROM THE REAR**

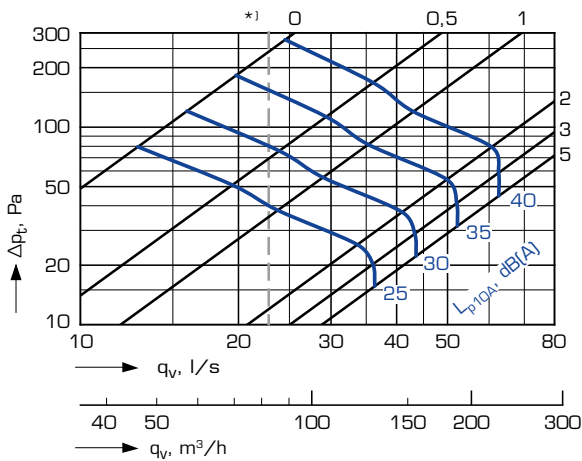

**DYVB-125-2 WITH CONNECTION FROM THE SIDE**

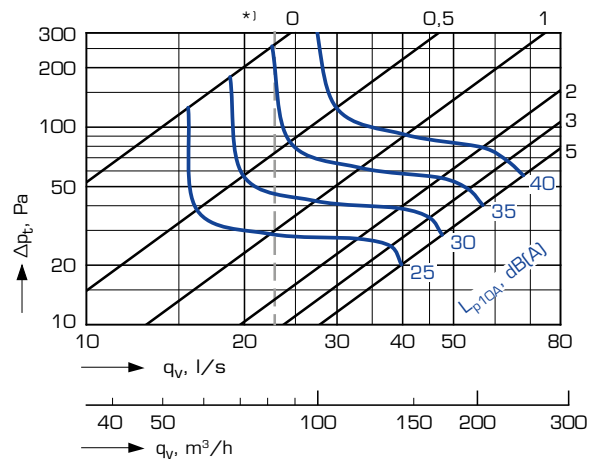

**DYVB-160-1 WITH CONNECTION FROM THE REAR**

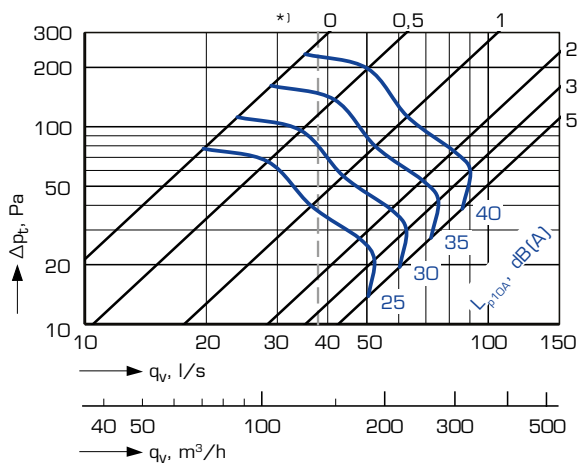

**DYVB-160-2 WITH CONNECTION FROM THE SIDE**

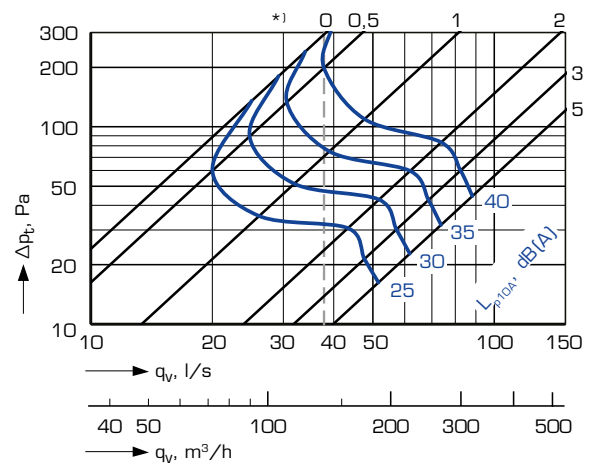

**DYVB-200-1 WITH CONNECTION FROM THE REAR**

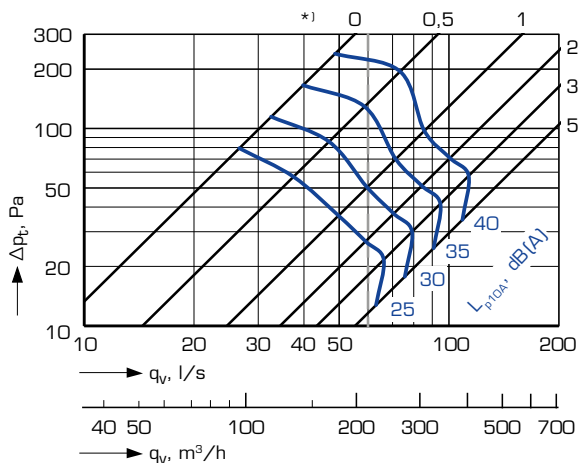

**DYVB-200-2 WITH CONNECTION FROM THE SIDE**

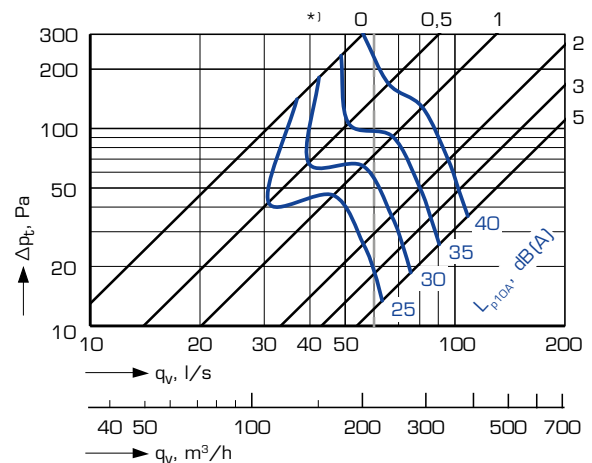

- - - Min. airflow required to obtain sufficient measuring pressure.

## ACOUSTIC DATA

### SOUND POWER LEVEL $L_W$

Connection from the rear

DYVB	Correction of sound level K (dB)							
	63	125	250	500	1000	2000	4000	8000
100-1	8	2	8	3	-4	-8	-12	-13
125-1	8	1	6	3	-3	-6	-12	-16
160-1	7	2	7	3	-2	-8	-13	-17
200-1	4	3	7	3	-3	-9	-14	-16
Tolerance ±	6	3	2	2	2	2	2	3

Connection from the side

DYVB	Correction of sound level K (dB)							
	63	125	250	500	1000	2000	4000	8000
100-2	9	3	8	2	-2	-9	-11	-12
125-2	6	1	6	2	-1	-7	-11	-16
160-2	5	3	6	2	-2	-6	-10	-14
200-2	4	4	5	4	-2	-8	-12	-15
Tolerance ±	6	3	2	2	2	2	2	3

Sound power levels by octave bands are obtained by adding to total sound pressure level  $L_{p10A}$  dB(A), the correction  $K_{oct}$  presented in the table according to the following formula:

$$L_W = L_{p10A} + K_{oct}$$

Correction  $K_{oct}$  is average value in range of use of the device.

### SOUND ATTENUATION $\Delta L$

DYVB	Sound attenuation (dB)							
	63	125	250	500	1000	2000	4000	8000
100	20	15	5	5	9	6	5	8
125	21	12	4	7	7	5	4	6
160	18	12	3	5	2	1	3	5
200	13	7	4	5	5	4	4	7
Tolerance ±	6	3	2	2	2	2	2	3

The average sound attenuation  $\Delta L$  from duct to room including the orifice attenuation of the connecting duct in wall installation, is obtained in the table above.

More technical data can be found in our selection tool. Contact our nearest sales office for further information.

## AIR STREAM DEFLECTION AND NUMBER OF NOZZLES

### AIR STREAM DEFLECTION - NOZZLE ADJUSTMENT

Throw	Normal	Concentrated
$b_v = L_{0,2} \times$	0,1	0,1
$b_h = L_{0,2} \times$	1,0	0,7

### NUMBER OF NOZZLES

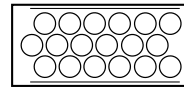

DYVZ-100

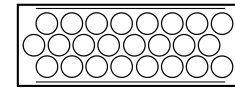

DYVZ-125

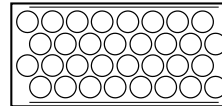

DYVZ-160

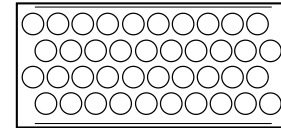

DYVZ-200

## DIMENSIONS AND WEIGHTS

### CONNECTION FROM THE REAR

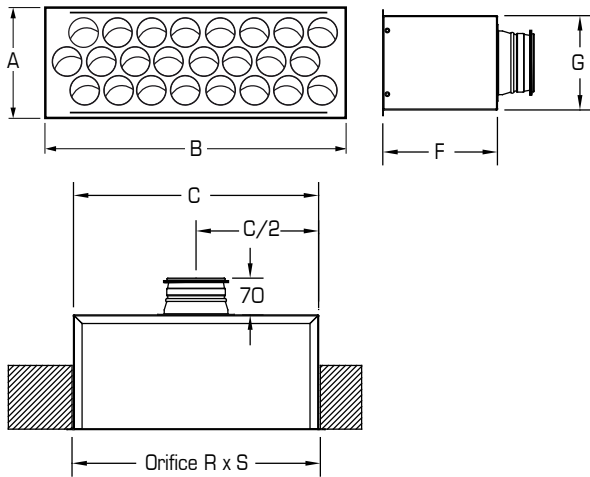

Size	A (mm)	B (mm)	C (mm)	ØD (mm)	F (mm)	G (mm)
100	195	437	385	99,3	180	149,5
125	195	537	485	124,3	180	149,5
160	245	537	485	159,3	200	199,5
200	295	637	585	199,3	220	249,5

Size	R (mm)	S (mm)	Weight (kg)
100	390	155	2,4
125	490	155	2,9
160	490	205	3,5
200	590	255	4,5

### CONNECTION FROM THE SIDE

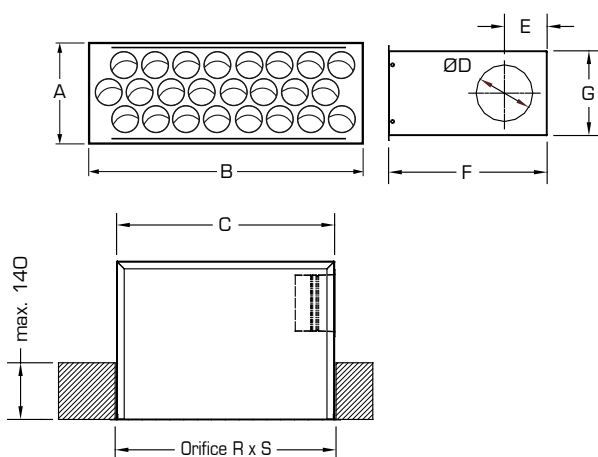

Size	A (mm)	B (mm)	C (mm)	ØD (mm)	E (mm)	F (mm)	G (mm)
100	195	437	385	100	74	280	149,5
125	195	537	485	125	86	305	149,5
160	245	537	485	160	104	340	199,5
200	295	637	585	200	124	380	249,5

Size	R (mm)	S (mm)	Weight (kg)
100	390	155	3,0
125	490	155	3,8
160	490	205	4,5
200	590	255	5,9

## DIFFUSION PATTERN AND PRODUCT SUMMARY

### ADJUSTABLE DIFFUSION PATTERN

The diffuser with its nozzles has an infinite number of possible settings. The nozzle diffusers are supplied with the nozzles set for a normal diffusion pattern, see the figure below. We also recommend, in addition to the delivery execution, the following possible basic settings: 1-way concentrated and 2-way wall diffusion. Individual settings are also possible.

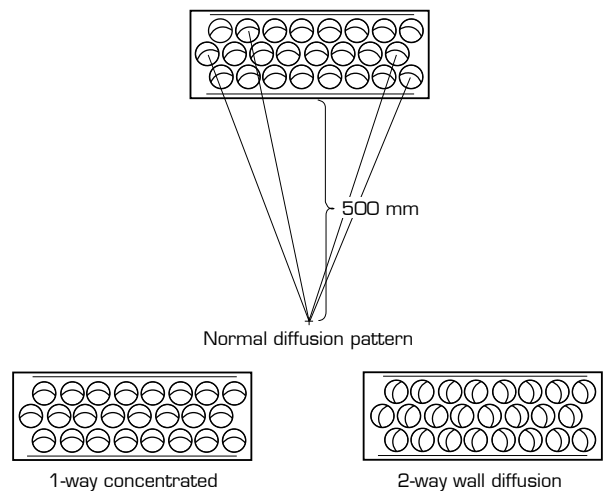

### PRODUCT SUMMARY

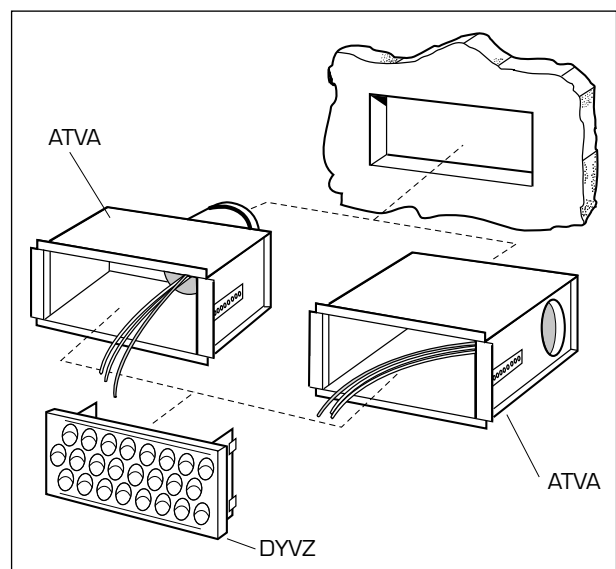

## GENERAL

### EXECUTION AND FUNCTION

DYVB is a quiet wall mounted supply air unit that consists of a nozzle diffuser DYVZ and a plenum box ATVA. The diffuser has adjustable nozzles for the setting of an optional diffusion pattern. The design of the nozzles gives very good mixing of the room air (high induction). The nozzles are rotatable and offer the possibility of changing the diffusion pattern and the diffusion direction for adaptation to the actual installation and device position.

The ATVA plenum box features an extremely quiet patented measurement and adjustment damper for multipoint measuring with balanced and accurate values. The adjustment handle of the measurement and adjustment damper has a position indicator and a locking device. The measurement and adjustment damper can be easily removed for inspection and cleaning without changing the setting. Duct connection from the side or from the rear.

### MATERIAL AND SURFACE FINISH

Both the diffuser and plenum box are made from steel sheet. The diffuser is powder-coated for a high surface finish. The standard colour is RAL 9010. Other diffuser colours are available on special order. The nozzles are made of white plastic and have antistatic treatment.

### INSTALLATION, ADJUSTMENT AND MAINTENANCE

The instructions for installation, adjustment and maintenance are available at [www.flaktgroup.com](http://www.flaktgroup.com). The k-factors for supply air are also provided on the plenum box.

### TECHNICAL DATA AND DIMENSIONING

The indicated sound pressure levels dB(A) are applicable for 10 m<sup>2</sup> room absorption.

The throw of  $I_{0,2}$  is measured for isothermal injection. The recommended maximum under temperature is 12 °C.

For complete design details, please see the FläktGroup product selection program. The program can be found on the Internet at [www.flaktgroup.com](http://www.flaktgroup.com).

### DESCRIPTIVE TEXT

The DYVB supply air unit by FläktGroup is intended for wall mounting and consists of a nozzle diffuser DYVZ and a plenum box ATVA. The DYVZ has adjustable nozzles. The ATVA plenum box includes a quiet, easily removable measurement and adjustment damper (ZAEF).

## PRODUCT CODE

### Nozzle diffuser with connection box

DYVB-aaa-b

#### Size (aaa)

100, 125, 160, 200

#### Connection (b)

1 = from the rear  
2 = from the side

### Nozzle diffuser

DYVZ-aaa

### Nozzle diffuser, special colour

DYVZ-aaa-E

#### Size (aaa)

100, 125, 160, 200

### Connection box

ATVA-aaa-b

#### Size (aaa)

100, 125, 160, 200

#### Connection alternatives (b)

1 = from the rear  
2 = from the side

## **EXCELLENCE IN SOLUTIONS**

FläktGroup is the European market leader for smart and energy efficient Indoor Air and Critical Air solutions to support every application area. We offer our customers innovative technologies, high quality and outstanding performance supported by more than a century of accumulated industry experience. The widest product range in the market, and strong market presence in 65 countries worldwide, guarantee that we are always by your side, ready to deliver Excellence in Solutions.

### **PRODUCT FUNCTIONS BY FLÄKTGROUP**

Air Treatment | Air Movement | Air Diffusion | Air Distribution | Air Filtration  
Air Management & ATD's | Air Conditioning & Heating | Controls | Service

» Learn more on [www.flaktgroup.com](http://www.flaktgroup.com)  
or contact one of our offices